



assembly manual

ANÆ tree grate model Our

tree grate height: 4cm

ANÆ streetfurniture
Het Rondeel 17
6219 PG Maastricht
t +31 (0)433 255 145
e info@ANÆ.eu
i www.ANÆ.eu

25-04-2017



index

product picture	3
regulation	4
tree grate with light frame	5
tree grate with heavy frame	6
section with frames	7
assembly steps	8
assembly frame	10
assembly tree grate	11

product picture

ANÆ tree grate model Our

tree grate height: 4cm



regulation ⚠

ANÆ tree grate model Our

tree grate height: 4cm

Installation and maintenance may be only performed with original components.

The national and international rules must be used. ANÆ Streetfurniture is not responsible for damage caused by improper use. Installation has to be done by qualified personnel.

Tree grates may only be used for prescribed purpose.

Vehicle pressure may not be applied to the treegrates before completion of assembly protocol.

When, using M12 sets, the surface of the grates is not level across the segments after placement M10 sets need to be applied. ANÆ can supply these sets.

The images in this document are indicative for the model. Some discrepancies between image and product may occur with different model and sizes.



tree grate with light frame
ANÆ tree grate model Our
 tree grate height: 4cm

Tree grate - four parts

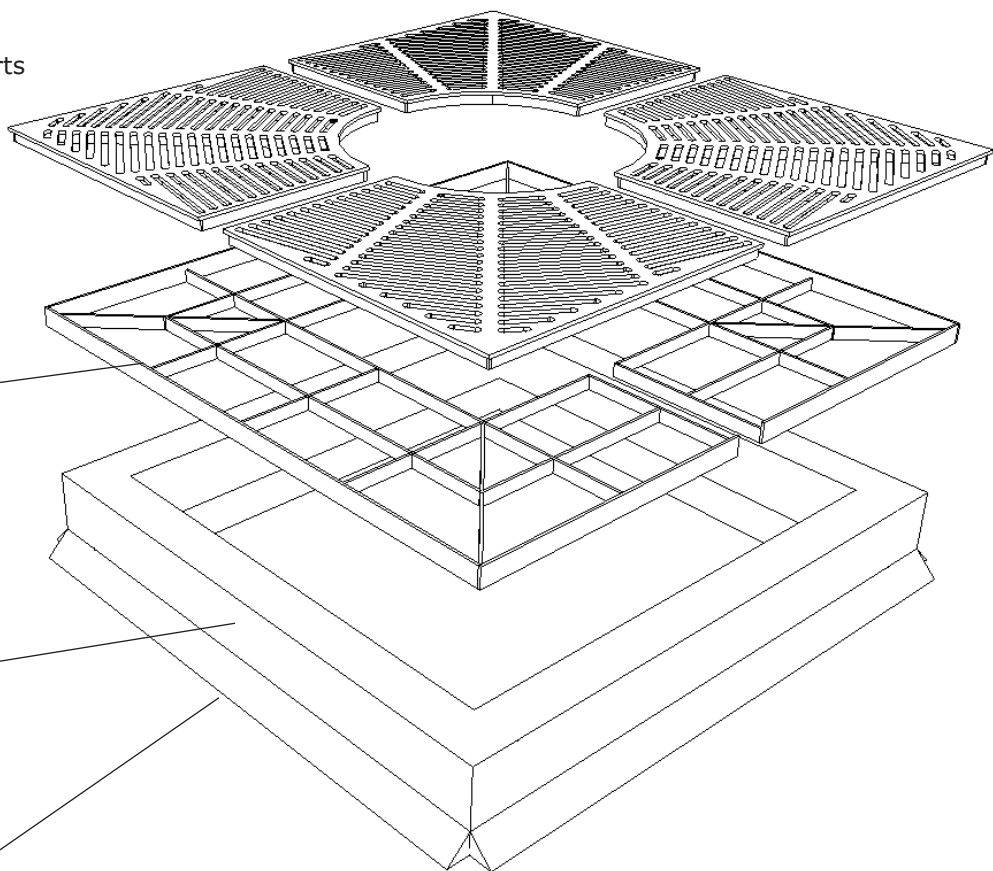

Light frame
 two or four parts

Concrete Curbstone
 250x150 mm o.e.
 (not included)

Concrete foundation
 (not included)

Pic. 1

Attention:

With grates larger than 2 meters support tiles need to be applied around the opening in the grate.
 Only by properly installing the system, a traffic class B for cars according to NEN-EN 1991-2: 2003 has been achieved.

tree grate with heavy frame
ANÆ tree grate model Our
 tree grate height: 4cm

Tree grate - four parts

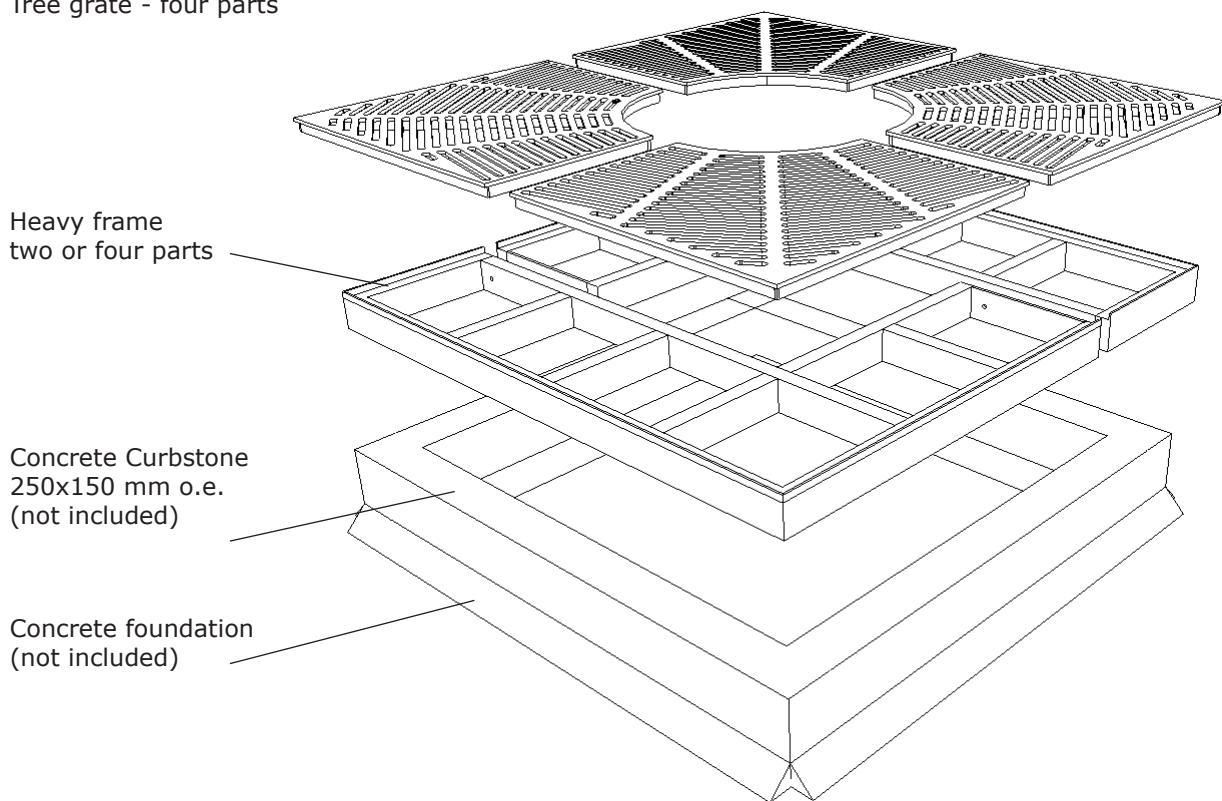

Pic. 2

Attention:

With grates larger than 2 meters support tiles need to be applied around the opening in the grate.
 Only by properly installing the system, a traffic class C for trucks according to NEN-EN 1991-2: 2003 has been achieved.

section with frames

ANÆ tree grate model Our

tree grate height: 4cm

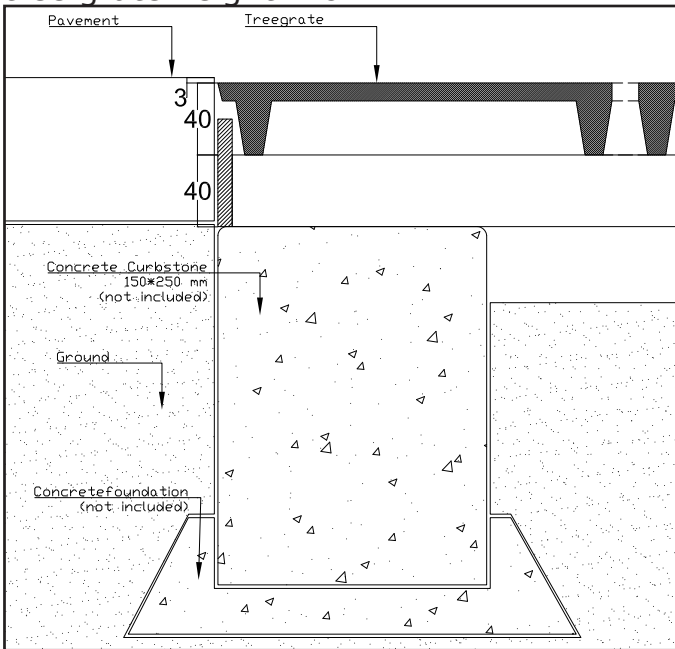

Pic. 3
Light frame

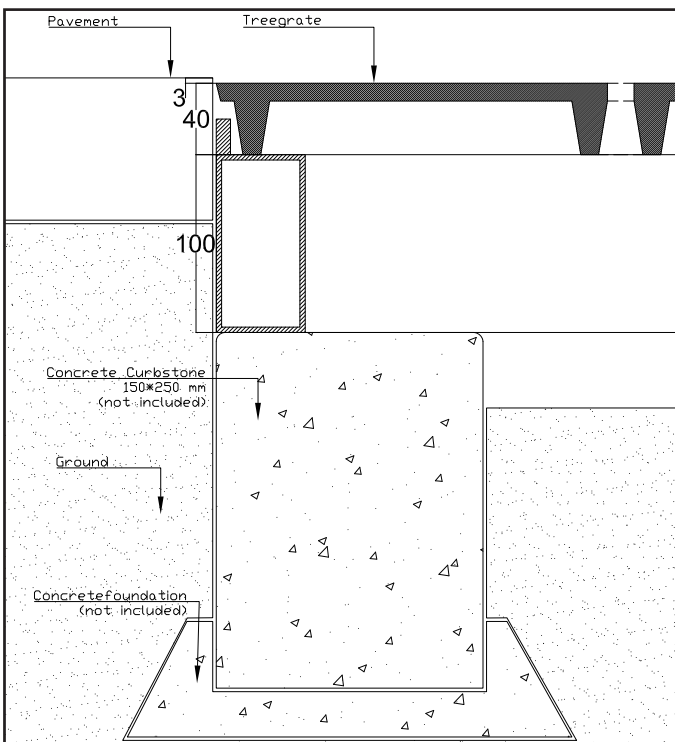

Pic. 4
Heavy frame

ANÆ streetfurniture

Het Rondeel 17

6219 PG Maastricht

t +31 (0)433 255 145

e info@ANÆ.eu

i www.ANÆ.eu

25-04-2017

assembly steps

ANÆ tree grate model Our

tree grate height: 4cm

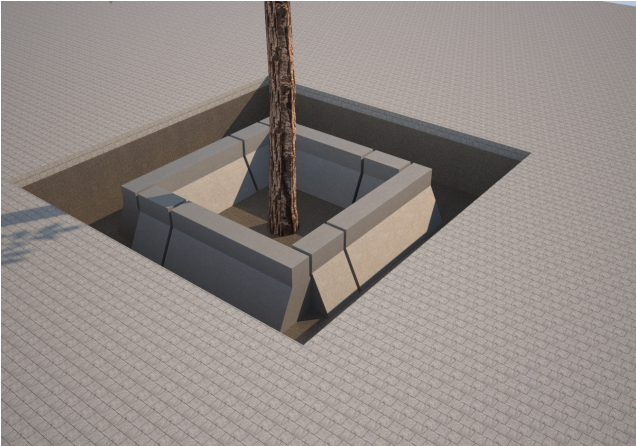

Place Foundation
Curbstones of 250x150x1000 or similar (not included) all around. Where necessary provide gaps for roots. After checking that the curbstones are level set them in concrete.

pic. 5
Foundation

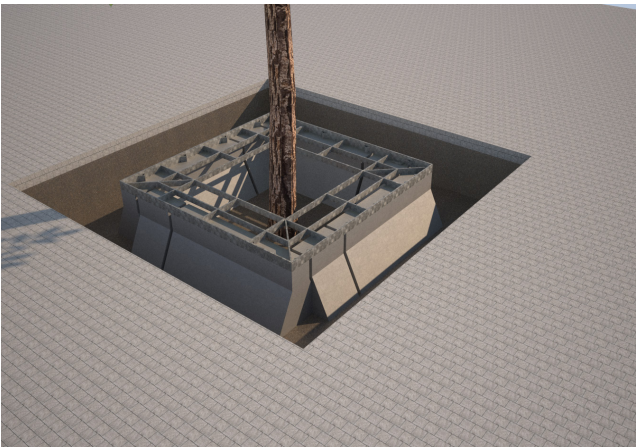

Place frame
Place the ANÆ light or heavy frame on the curbstones. Pay attention to the total height! See sections.

pic. 6
Frame

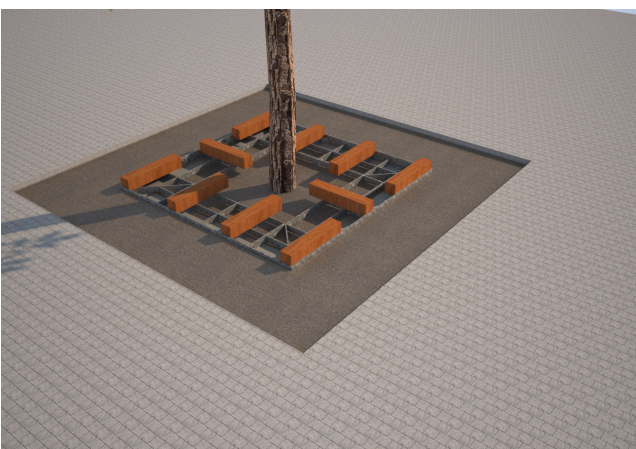

Temporary wooden beams
To be able to place and assemble the tree-grate based on manpower alone we suggest placing wooden beams on the frame. These beams allow access to the connection holes of the grate's segments. Attention! the beams need to be placed inside of the raised strip of the frame.

pic. 7
Temporary beams

assembly steps

ANÆ tree grate model Our

tree grate height: 4cm

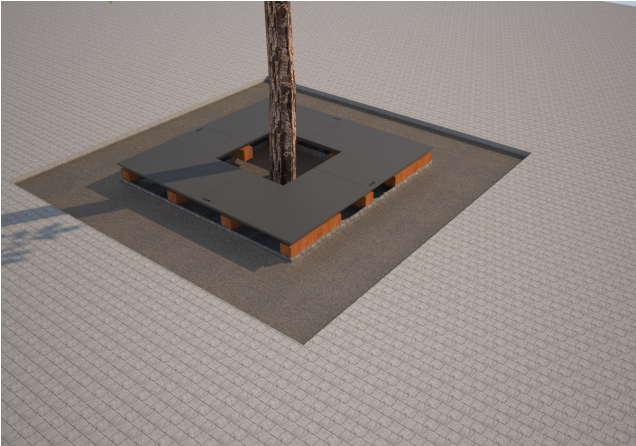

Place Tree-grate
Place the grate segments on top of the wooden beams and interconnect them.

pic. 8
Tree-grate on wooden beams

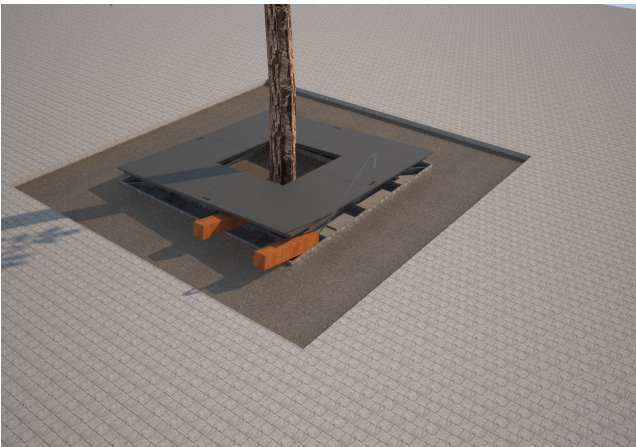

Remove beams
By using a crowbar, or something similar, lift the interconnected grate segments so that you can remove the beams from underneath the grate.

pic. 9
Placing the grate

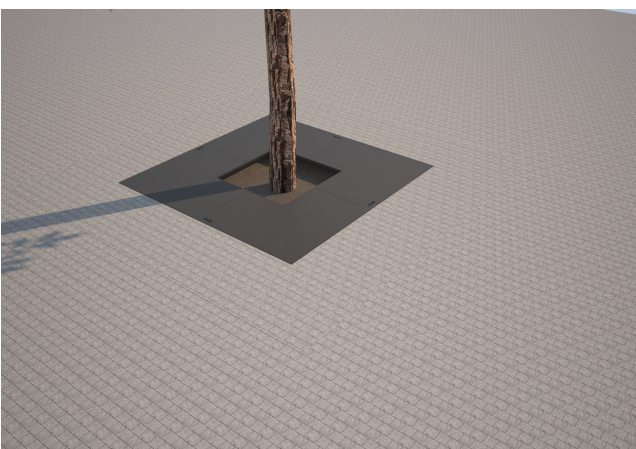

Finish pavement
Check to make sure the grate lays inside the raised strips of the frame. If so finish placing the pavement.

pic. 10
Result

assembly frames

ANÆ tree grate model Our

tree grate height: 4cm

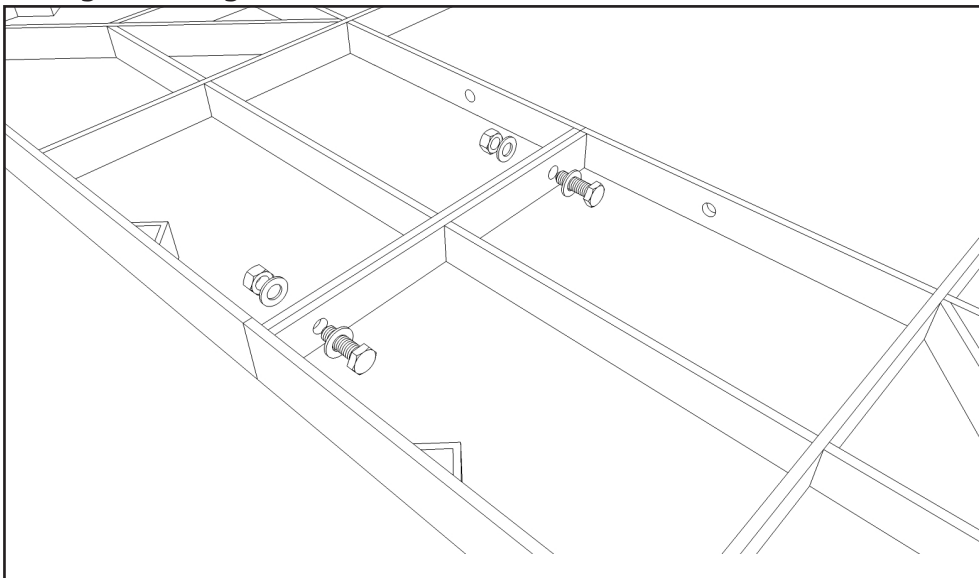

Pic. 11 Light Frame
 Bolts DIN933 M12
 Rings DIN125
 Nuts DIN985 M12

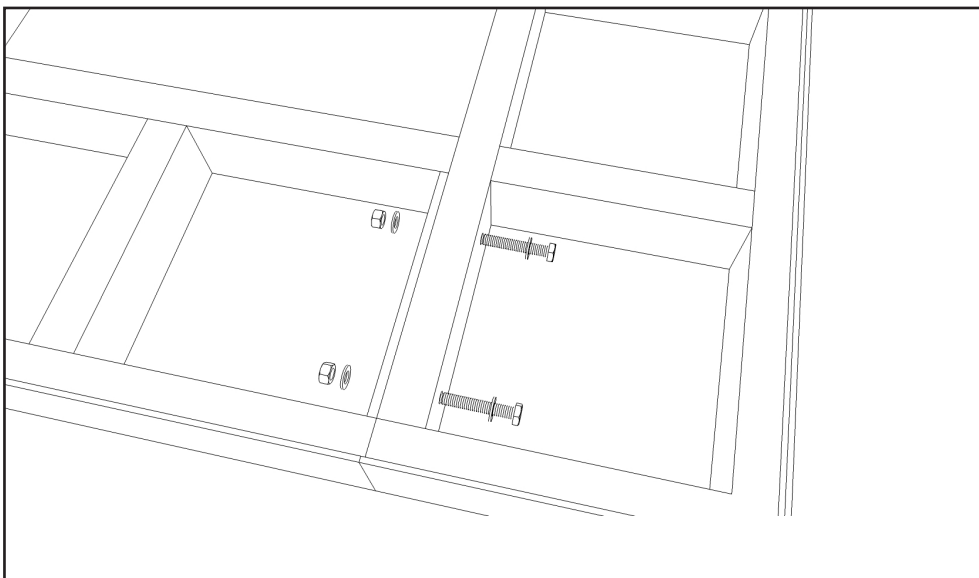

Pic. 12 Heavy Frame
 Bolts DIN933 M12
 Rings DIN125
 Nuts DIN985 M12

ANÆ streetfurniture
 Het Rondeel 17
 6219 PG Maastricht
 t +31 (0)433 255 145
 e info@ANÆ.eu
 i www.ANÆ.eu

assembly tree grate

ANÆ tree grate model Our

tree grate height: 4cm

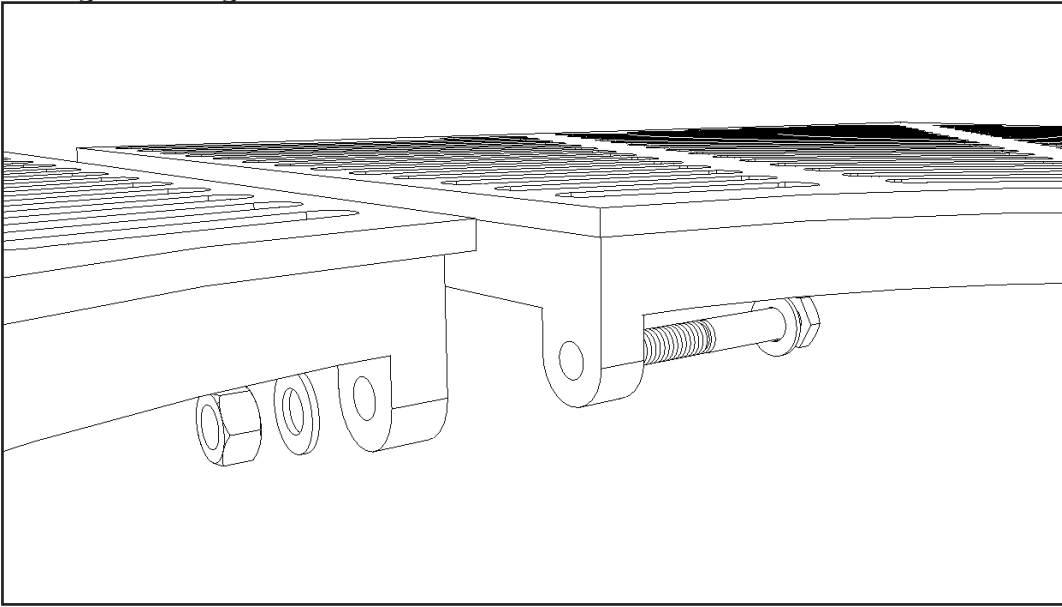

Pic. 13

Bolts DIN933 M12
Rings DIN125
Nuts DIN985 M12